

Silicon NPN Phototransistor

Description

BPV11F is a very high sensitive silicon NPN epitaxial planar phototransistor in a standard T-1 $\frac{3}{4}$ plastic package.

The epoxy package itself is an IR filter, spectrally matched to GaAs IR emitters ($\lambda_p \geq 900$ nm).

The viewing angle of $\pm 15^\circ$ makes it insensible to ambient straylight.

A base terminal is available to enable biasing and sensitivity control.

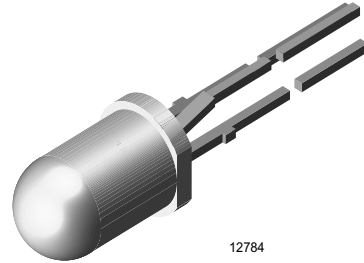

Features

- Very high radiant sensitivity
- Standard T-1 $\frac{3}{4}$ (\varnothing 5 mm) package
- IR filter for GaAs emitters (950 nm)
- Angle of half sensitivity $\varphi = \pm 15^\circ$
- Base terminal available
- Lead (Pb)-free component
- Component in accordance to RoHS 2002/95/EC and WEEE 2002/96/EC



Applications

- Detector for industrial electronic circuitry, measurement and control

Absolute Maximum Ratings

$T_{amb} = 25^\circ\text{C}$, unless otherwise specified

Parameter	Test condition	Symbol	Value	Unit
Collector Base Voltage		V_{CBO}	80	V
Collector Emitter Voltage		V_{CEO}	70	V
Emitter Base Voltage		V_{EBO}	5	V
Collector current		I_C	50	mA
Collector peak current	$t_p/T = 0.5$, $t_p \leq 10$ ms	I_{CM}	100	mA
Total Power Dissipation	$T_{amb} \leq 47^\circ\text{C}$	P_{tot}	150	mW
Junction Temperature		T_j	100	$^\circ\text{C}$
Storage Temperature Range		T_{stg}	- 55 to + 100	$^\circ\text{C}$
Soldering Temperature	$t \leq 5$ s, 2 mm from body	T_{sd}	260	$^\circ\text{C}$
Thermal Resistance Junction/ Ambient		R_{thJA}	350	K/W

Electrical Characteristics

$T_{amb} = 25\text{ }^{\circ}\text{C}$, unless otherwise specified

Parameter	Test condition	Symbol	Min	Typ.	Max	Unit
Collector Emitter Breakdown Voltage	$I_C = 1\text{ mA}$	$V_{(BR)CEO}$	70			V
Collector-emitter dark current	$V_{CE} = 10\text{ V}, E = 0$	I_{CEO}		1	50	nA
DC Current Gain	$V_{CE} = 5\text{ V}, I_C = 5\text{ mA}, E = 0$	h_{FE}		450		
Collector-emitter capacitance	$V_{CE} = 0\text{ V}, f = 1\text{ MHz}, E = 0$	C_{CEO}		15		pF
Collector - base capacitance	$V_{CB} = 0\text{ V}, f = 1\text{ MHz}, E = 0$	C_{CBO}		19		pF

Optical Characteristics

$T_{amb} = 25\text{ }^{\circ}\text{C}$, unless otherwise specified

Parameter	Test condition	Symbol	Min	Typ.	Max	Unit
Collector Light Current	$E_e = 1\text{ mW/cm}^2, \lambda = 950\text{ nm}, V_{CE} = 5\text{ V}$	I_{ca}	3	9		mA
Angle of Half Sensitivity		ϕ		± 15		deg
Wavelength of Peak Sensitivity		λ_p		930		nm
Range of Spectral Bandwidth		$\lambda_{0.5}$		900 to 980		nm
Collector Emitter Saturation Voltage	$E_e = 1\text{ mW/cm}^2, \lambda = 950\text{ nm}, I_C = 1\text{ mA}$	V_{CEsat}		130	300	mV
Turn-On Time	$V_S = 5\text{ V}, I_C = 5\text{ mA}, R_L = 100\text{ }\Omega$	t_{on}		6		μs
Turn-Off Time	$V_S = 5\text{ V}, I_C = 5\text{ mA}, R_L = 100\text{ }\Omega$	t_{off}		5		μs
Cut-Off Frequency	$V_S = 5\text{ V}, I_C = 5\text{ mA}, R_L = 100\text{ }\Omega$	f_c		110		kHz

Typical Characteristics

$T_{amb} = 25\text{ }^{\circ}\text{C}$ unless otherwise specified

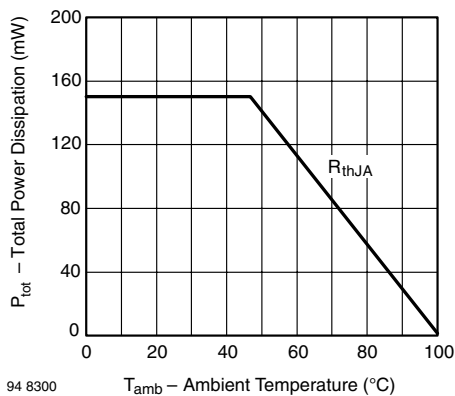

Figure 1. Total Power Dissipation vs. Ambient Temperature

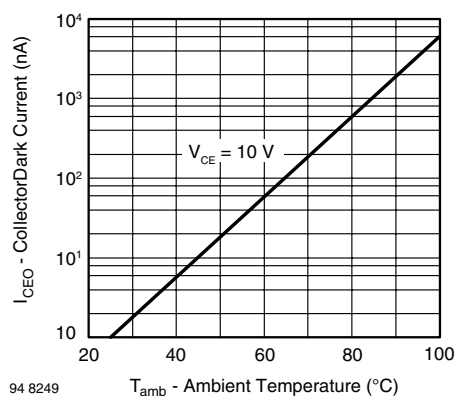

Figure 2. Collector Dark Current vs. Ambient Temperature

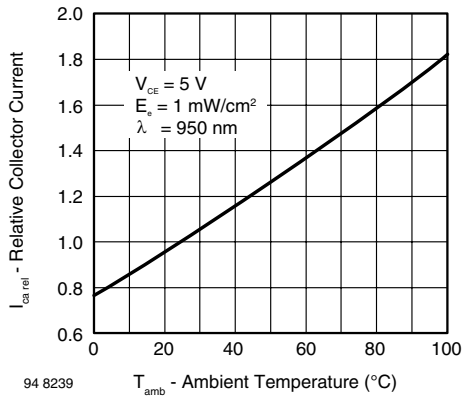

Figure 3. Relative Collector Current vs. Ambient Temperature

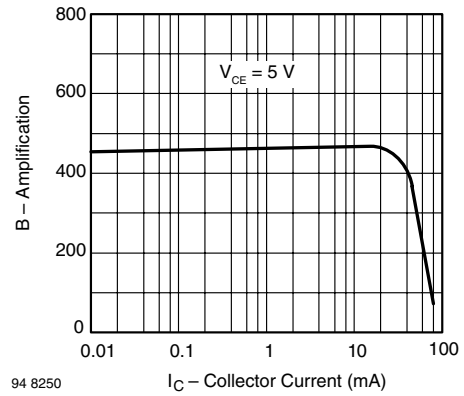

Figure 6. Amplification vs. Collector Current

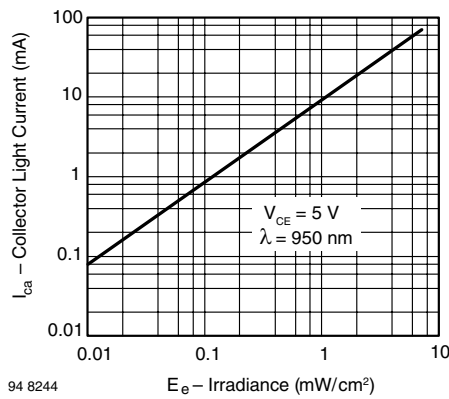

Figure 4. Collector Light Current vs. Irradiance

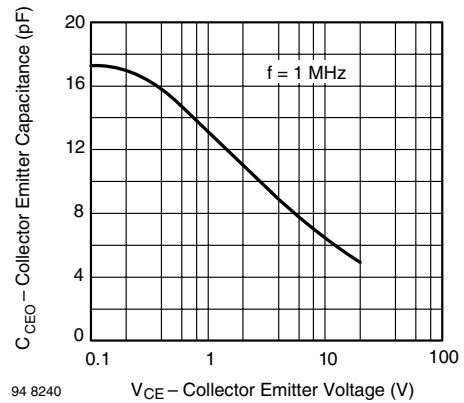

Figure 7. Collector Base Capacitance vs. Collector Base Voltage

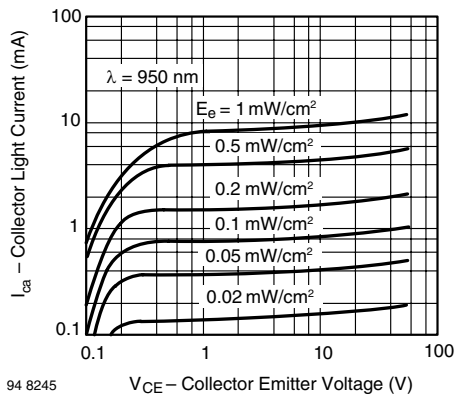

Figure 5. Collector Light Current vs. Collector Emitter Voltage

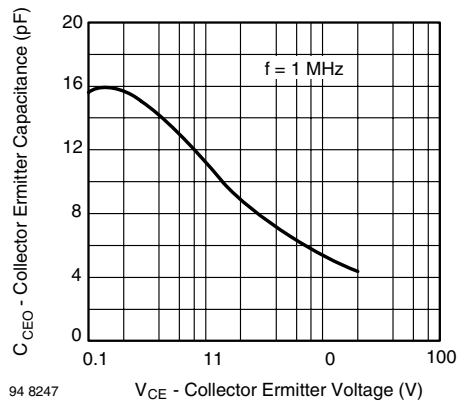
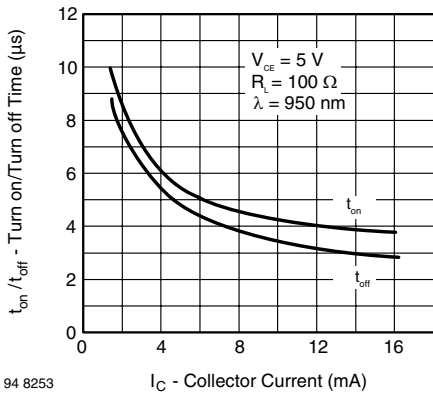
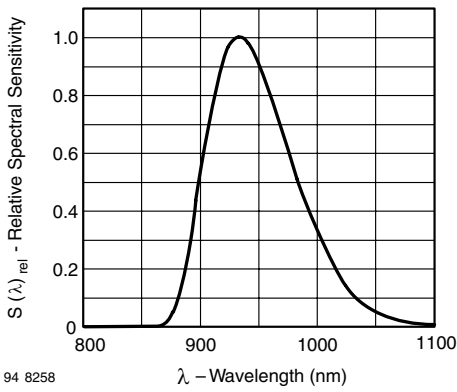

Figure 8. Collector Emitter Capacitance vs. Collector Emitter Voltage



94 8253

Figure 9. Turn On/Turn Off Time vs. Collector Current



94 8258

Figure 10. Relative Spectral Sensitivity vs. Wavelength

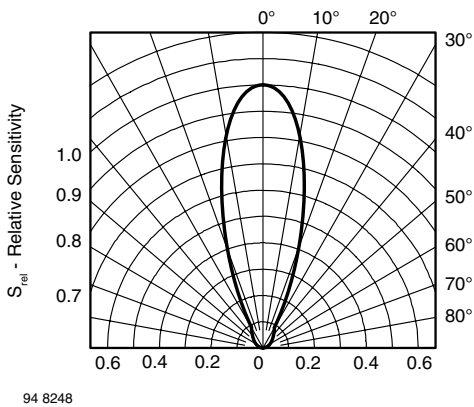

94 8248

Figure 11. Relative Radiant Sensitivity vs. Angular Displacement

Package Dimensions in mm

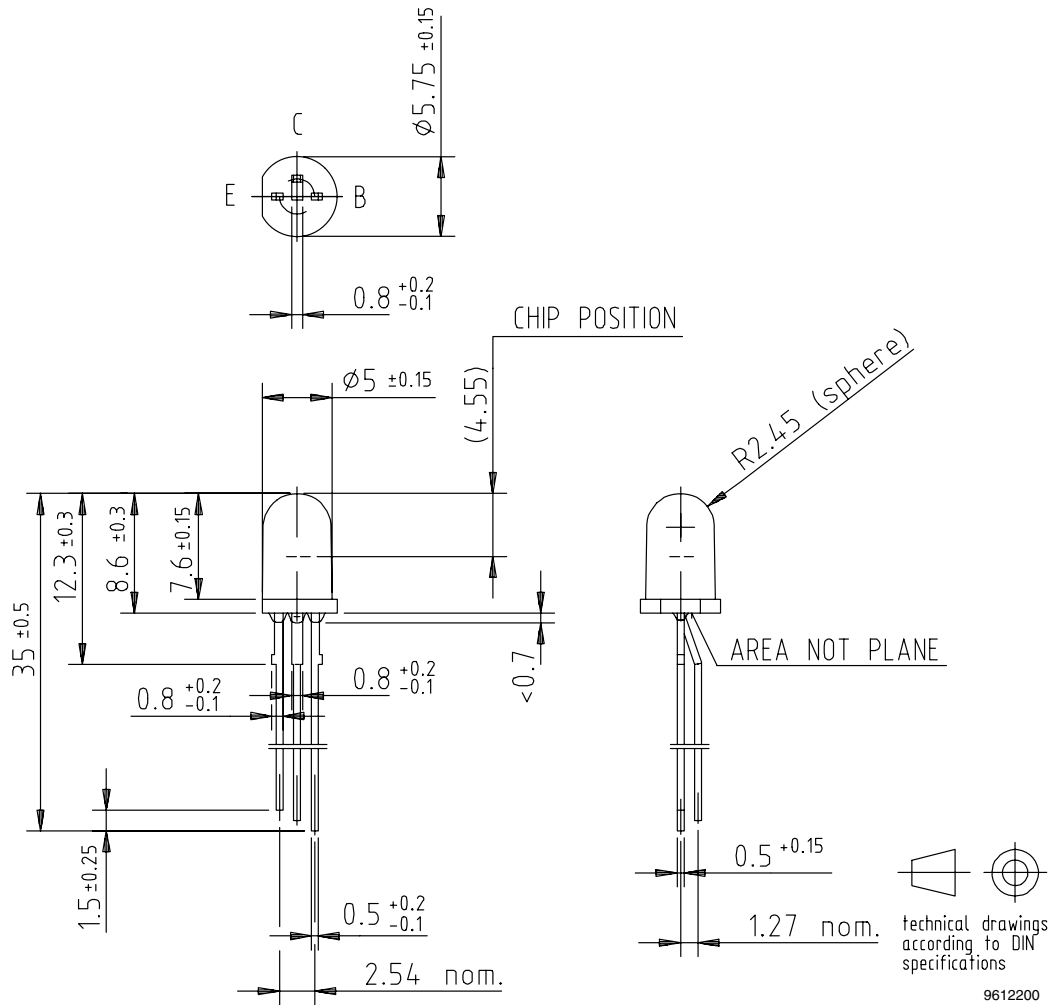

Ozone Depleting Substances Policy Statement

It is the policy of Vishay Semiconductor GmbH to

1. Meet all present and future national and international statutory requirements.
2. Regularly and continuously improve the performance of our products, processes, distribution and operating systems with respect to their impact on the health and safety of our employees and the public, as well as their impact on the environment.

It is particular concern to control or eliminate releases of those substances into the atmosphere which are known as ozone depleting substances (ODSs).

The Montreal Protocol (1987) and its London Amendments (1990) intend to severely restrict the use of ODSs and forbid their use within the next ten years. Various national and international initiatives are pressing for an earlier ban on these substances.

Vishay Semiconductor GmbH has been able to use its policy of continuous improvements to eliminate the use of ODSs listed in the following documents.

1. Annex A, B and list of transitional substances of the Montreal Protocol and the London Amendments respectively
2. Class I and II ozone depleting substances in the Clean Air Act Amendments of 1990 by the Environmental Protection Agency (EPA) in the USA
3. Council Decision 88/540/EEC and 91/690/EEC Annex A, B and C (transitional substances) respectively.

Vishay Semiconductor GmbH can certify that our semiconductors are not manufactured with ozone depleting substances and do not contain such substances.

We reserve the right to make changes to improve technical design
and may do so without further notice.

Parameters can vary in different applications. All operating parameters must be validated for each customer application by the customer. Should the buyer use Vishay Semiconductors products for any unintended or unauthorized application, the buyer shall indemnify Vishay Semiconductors against all claims, costs, damages, and expenses, arising out of, directly or indirectly, any claim of personal damage, injury or death associated with such unintended or unauthorized use.

Vishay Semiconductor GmbH, P.O.B. 3535, D-74025 Heilbronn, Germany



Disclaimer

All product specifications and data are subject to change without notice.

Vishay Intertechnology, Inc., its affiliates, agents, and employees, and all persons acting on its or their behalf (collectively, "Vishay"), disclaim any and all liability for any errors, inaccuracies or incompleteness contained herein or in any other disclosure relating to any product.

Vishay disclaims any and all liability arising out of the use or application of any product described herein or of any information provided herein to the maximum extent permitted by law. The product specifications do not expand or otherwise modify Vishay's terms and conditions of purchase, including but not limited to the warranty expressed therein, which apply to these products.

No license, express or implied, by estoppel or otherwise, to any intellectual property rights is granted by this document or by any conduct of Vishay.

The products shown herein are not designed for use in medical, life-saving, or life-sustaining applications unless otherwise expressly indicated. Customers using or selling Vishay products not expressly indicated for use in such applications do so entirely at their own risk and agree to fully indemnify Vishay for any damages arising or resulting from such use or sale. Please contact authorized Vishay personnel to obtain written terms and conditions regarding products designed for such applications.

Product names and markings noted herein may be trademarks of their respective owners.

Mouser Electronics

Authorized Distributor

Click to View Pricing, Inventory, Delivery & Lifecycle Information:

[Vishay:](#)

[BPV11F](#)